

MK NEW ITEM / INTERCHANGE NEWS

Date : NOVEMBER 20, 2018

No. 18 - 11

We will exhibit at AUTOMECHANIKA SHANGHAI 2018
Please visit to MK booth !!

automechanika

SHANGHAI

Visit us at Hall2 2C79

28.11 – 1.12.2018

National Exhibition and Convention
Center (Shanghai)



NOVEMBER New Item Information

BRAKE PAD

MK No.	Application	Releasing Month (accepting order)	Quotation Month
D11421MH Made in Indonesia	KIA MORNING, PICANTO EUR 15.01- KIA MORNING KOR 15.03- KIA PICANTO AUS 16.03-16.11	NOV. 2018	NOV. 2018
D20073H Made in Indonesia FMSI NO. 7915-D1011 7915-D1083	FORD F-150 USA 2004-2009 LINCOLN MARK LT USA 2006-2007	NOV. 2018	NOV. 2018

BRAKE SHOE

MK No.	Application	Releasing Month (accepting order)	Quotation Month
K0046 Made in Japan	DAIHATSU MOVE LA160S (4WD) 14.11- DAIHATSU TANTO LA610S (4WD) 15.05- DAIHATSU CAST LA260 (4WD) 15.09- DAIHATSU BOON M710S (4WD) 16.04- DAIHATSU MIRA E:S LA360S (4WD) 17.04- DAIHATSU MIRA TOCOT LA560S (4WD) 18.06- DAIHATSU MOVE CANBUS LA810S (4WD) 16.08- DAIHATSU WAKE LA710S (4WD) 16.05- DAIHATSU HIJET CADDIE LA710V (4WD) 16.05- SUBARU STELLA LA160F (4WD) 14.11- SUBARU CHIFFON LA610F (4WD) 16.11- SUBARU PLEO PLUS LA360F (4WD) 17.04- TOYOTA PASSO M710A (4WD) 16.04- TOYOTA PIXIS EPOCH LA360A (4WD) 17.05- TOYOTA PIXIS JOY LA260A (4WD) 16.09- TOYOTA PIXIS MEGA LA710A (4WD) 16.05-	NOV. 2018	NOV. 2018

BRAKE SHOE

MK No.	Application	Releasing Month (accepting order)	Quotation Month
K0051 Made in Japan	DAIHATSU MOVE LA150S (2WD) 14.11- DAIHATSU TANTO LA600S (2WD) 15.05- DAIHATSU CAST LA250 (2WD) 15.09- DAIHATSU BOON M700S (2WD) 16.04- DAIHATSU THOR M900S (2WD) 16.11- DAIHATSU MOVE CANBUS LA800S (2WD) 16.08- DAIHATSU WAKE LA700S (2WD) 16.05- DAIHATSU HIJET CADDIE LA700V (2WD) 16.05- SUBARU STELLA LA150F (2WD) 14.11- SUBARU CHIFFON LA600F (2WD) 16.11- SUBARU JUSTY M900F (2WD) 16.11- TOYOTA PASSO M700A (2WD) 16.04- TOYOTA TANK/ROOMY M900A (2WD) 16.11- TOYOTA PIXIS JOY LA250A (2WD) 16.09- TOYOTA PIXIS MEGA LA700A (2WD) 16.05-	NOV. 2018	NOV. 2018
K0056 Made in Japan	DAIHATSU HIJET TRUCK S500P, S510P 15.11- SUBARU SAMBAR TRUCK S500J, S510J 15.11- TOYOTA PIXIS TRUCK S500U, S510U 15.11-	NOV. 2018	NOV. 2018
K9005 Made in Japan	SUZUKI EVERY DA17V 15.02- SUZUKI EVERY WAGON DA17W 15.02- NISSAN NV100 CLIPPER DR17V 15.03- NISSAN NV100 CLIPPER RIO DR17W 15.03- MITSUBISHI TOWNBOX DS17W 15.03- MITSUBISHI MINICAB VAN DS17V 15.03- MAZDA SCRUM VAN DG17V 15.02- MAZDA SCRUM WAGON DG17W 15.02-	NOV. 2018	NOV. 2018

NOVEMBER New Item Drawing Information

BRAKE PAD

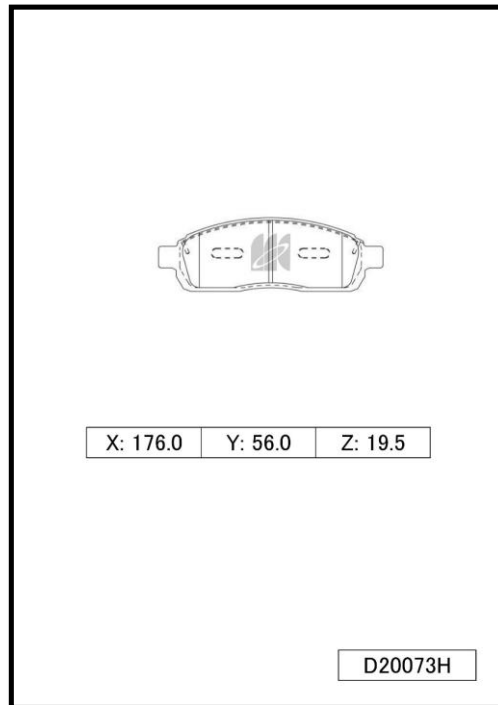
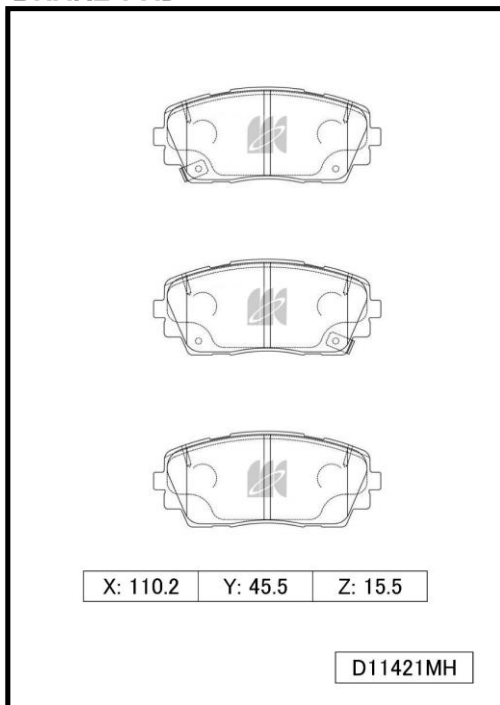

BRAKE SHOE



a	b	c	R	Shoe Only No.
2.9	1.6	24.5	90.0	M0046



a	b	c	R	Shoe Only No.
2.9	1.6	24.5	90.0	M0047



a	b	c	R	Shoe Only No.
2.9	1.6	24.5	90.0	M0048



a	b	c	R	Shoe Only No.
2.9	1.6	24.5	90.0	M0049

K0046



a	b	c	R	Shoe Only No.
2.9	1.6	24.5	90.0	M0051



a	b	c	R	Shoe Only No.
2.9	1.6	24.5	90.0	M0052



a	b	c	R	Shoe Only No.
2.9	1.6	24.5	90.0	M0053



a	b	c	R	Shoe Only No.
2.9	1.6	24.5	90.0	M0054

K0051



a	b	c	R	Shoe Only No.
3.2	1.6	30.0	90.0	M0056



a	b	c	R	Shoe Only No.
3.2	1.6	30.0	90.0	M0057



a	b	c	R	Shoe Only No.
3.2	1.6	30.0	90.0	M0058



a	b	c	R	Shoe Only No.
3.2	1.6	30.0	90.0	M0059

K0056



a	b	c	R	Shoe Only No.
2.9	1.6	30.0	90.0	M9005



a	b	c	R	Shoe Only No.
2.9	1.6	30.0	90.0	M9006

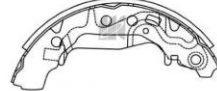

a	b	c	R	Shoe Only No.
2.9	1.6	30.0	90.0	M9007

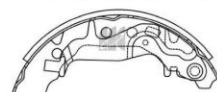

a	b	c	R	Shoe Only No.
2.9	1.6	30.0	90.0	M9008

K9005

"Valuable information" Interchange information (Existing MK item)

MK No.	Application	Year
D11352MH	HYUNDAI VELOSTER (1400cc,1600cc) <KOR>	2017.12-
D11355MH	KIA SPORTAGE (2000cc,2400cc) <USA>	2015.12-
D11373MH	HYUNDAI KONA (1600cc,2000cc) <EUR,KOR>	2017.06-
D11373MH	HYUNDAI VELOSTER (1400cc,1600cc) <KOR>	2017.12-
D11376MH	HYUNDAI ACCENT,ACCENT BLUE (1400cc,1600cc) RUSSIA PLANT <EUR,GEN>	2017.01-
D11376MH	HYUNDAI SOLARIS (1400cc,1600cc) RUSSIA PLANT <EUR,GEN>	2017.01-
D11376MH	KIA RIO,X-LINE (1400cc,1600cc) <EUR>	2017.06-
D11391MH	HYUNDAI GRAND STAREX (2400cc,2500cc) <KOR>	2017.12-
D11391MH	KIA SORENTO (2000cc,2400cc) <KOR>	2017.10-
D11412MH	HYUNDAI KONA (2000cc) 15INCH DISC <EUR,KOR>	2017.06-
D1286M	NISSAN LEAF ZE1E (UK MAKE) <EUR>	2017.07-2017.12
D1286M	NISSAN TEANA L33T (THAILAND MAKE) <GEN-RHD,THA>	2017.11-

MK No.	Application	Year
D1355M	NISSAN e-NV200 MEOM <EUR>	2017.10-
D1355M	NISSAN LEAF ZE1E (UK MAKE) <EUR>	2017.12-
D1355M	NISSAN LEAF ZE1U (US MAKE) <USA>	2017.12-
D1355M	NISSAN e-NV200 MEOM (SPAIN MAKE) <GEN-RHD>	2017.10-
D20060	FORD EDGE (2000cc,3500cc) <CHN>	2010-
D20062H	FORD EDGE (2000cc,3500cc) <CHN>	2010-
D20062H	FORD EXPLORER (2000cc,2300cc,3500cc) <CHN>	2011-
D20076M	FORD EDGE (2000cc,3500cc) <CHN>	2010-
D20076M	FORD EXPLORER (2000cc,2300cc,3500cc) <CHN>	2011-
D2317MH	TOYOTA AVENSIS WWT271 (2000cc) <EUR>	2017.06-
D5056MH	ACURA RSX (2000cc) <USA>	2002-2006
D5056MH	HONDA CIVIC COUPE (1800cc,2000cc) <USA>	2011
D5056MH	HONDA CIVIC SEDAN (1800cc,2000cc) <USA>	2011
D5128M	ACURA ILX (2000cc) <USA>	2013