

MK item / Interchange News

Date : NOVEMBER 16, 2017
No. 17 - 11

NOVEMBER NEW ITEM INFORMATION

BRAKE PAD







MK No.	Application	Releasing Month (accepting order)	Quotation Month
D2356H Made in Indonesia	LEXUS RX200T AGL20, AGL25 EUR 15.09- LEXUS RX350 GGL25 EUR, GCC 15.09- LEXUS RX450H GYL25 EUR, GCC 15.09-	NOV. 2017	NOV. 2017
D11388MH Made in Indonesia FMSI NO. D1962	KIA SORENTO 2200cc~3300cc EUR 14.09- KIA SORENTO 2200cc~3300cc GEN, ME 14.10- KIA SORENTO 2200cc, 2400cc RUS, CIS 14.11- KIA SORENTO 2200cc~3300cc AUS 15.04- KIA SORENTO 2000cc, 2200cc KOR 14.08-	NOV. 2017	NOV. 2017
D11394MH Made in Indonesia FMSI NO. D1917	HYUNDAI SANTA FE 3300cc USA 15.11- HYUNDAI SANTA FE 2200cc~3300cc GEN, ME 15.05- HYUNDAI SANTA FE 2200cc~3300cc AUS 15.06- HYUNDAI SANTA FE 2000cc, 2200cc KOR 15.05-	NOV. 2017	NOV. 2017

BRAKE SHOE

MK No.	Application	Releasing Month (accepting order)	Quotation Month
K1299 Made in Japan FMSI NO. S916	NISSAN CUBE Z12 EUR 09.08- NISSAN JUKE F15/F15E EUR 10.07- NISSAN LEAFE ZEO EUR 10.10-13.02 NISSAN QASHQAI J10E/JJ10E EUR 06.12-13.12 NISSAN TIIDA SC11X/C11X EUR 07.02- NISSAN X-TRAIL T31/T31R EUR, RUS 07.03-14.12 TOYOTA RAV4 ACA30/ALA40 EUR 05.11- NISSAN JUKE F15 USA, CAN 10.07- NISSAN LEAFE ZEO USA, CAN 10.10-12.12 NISSAN ROGUE S35 USA, CAN, MEX 07.08- NISSAN SENTRA B16U/B17U USA, CAN, MEX 06.09- NISSAN X-TRAIL T31 MEX 07.09-14.07 TOYOTA CAMRY AVX70 USA, CAN 17.03- LEXUS HS250H ANF10L USA, CAN 09.07-12.01 TOYOTA MATRIX AZE144/146 USA, CAN 08.01-11.11 TOYOTA RAV4 ACA33/ACA38 USA, CAN 05.11- NISSAN PULSAR B17TC/C12T AUS 12.11- NISSAN PULSAR C12T THA 13.01- NISSAN PULSAR C12T GEN 13.05- NISSAN BLUEBIRD SYLPHY G11Z CHN 06.08- NISSAN SERENA C26 IDN 12.12- NISSAN SERENA C26 MYS 14.07- INFINITI ESQ JF15 CHN 14.07- NISSAN JUKE F15 ZAF, GEN, GCC, KOR, TWN 10.07- NISSAN LEAF ZEO GEN 11.09-13.01 NISSAN QASHQAI J10E GEN, GCC, THA, TWN, ZAF 06.12-14.03 NISSAN QASHQAI J10E/JJ10E AUS 07.10- NISSAN ROGUE S35 KOR, TWN 07.09- NISSAN SENTRA B17U BRA 12.10- NISSAN SYLPHY G11Z/B17Z CHN 06.08- NISSAN SYLPHY B17T SGP, THA, PHL 12.07- NISSAN TIIDA C11Z CHN 07.11-09.02 NISSAN X-TRAIL T31 GEN, AUS, BRA, IND, ZAF, IDN, PHL 07.09- TOYOTA RAV4 ACA30/GSA33 GEN, AUS, GCC 05.11- TOYOTA RAV4 ASA42/ASA44 GEN, AUS, GCC 12.12- TOYOTA RAV4 ASA44/ALA49 ZAF 15.10-	NOV. 2017	NOV. 2017

NOVEMBER NEW Item Drawing Information

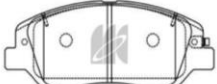
BRAKE PAD

 <table border="1" data-bbox="172 757 496 790"> <tr> <td>X: 167.0</td> <td>Y: 55.5</td> <td>Z: 17.0</td> </tr> </table> <p data-bbox="411 976 512 1010">D2356H</p>	X: 167.0	Y: 55.5	Z: 17.0	   <table border="1" data-bbox="563 913 887 947"> <tr> <td>X: 152.0</td> <td>Y: 55.5</td> <td>Z: 16.0</td> </tr> </table> <p data-bbox="810 976 911 1010">D11388MH</p>	X: 152.0	Y: 55.5	Z: 16.0	   <table border="1" data-bbox="962 913 1286 947"> <tr> <td>X: 156.8</td> <td>Y: 56.5</td> <td>Z: 16.0</td> </tr> </table> <p data-bbox="1206 976 1307 1010">D11394MH</p>	X: 156.8	Y: 56.5	Z: 16.0
X: 167.0	Y: 55.5	Z: 17.0									
X: 152.0	Y: 55.5	Z: 16.0									
X: 156.8	Y: 56.5	Z: 16.0									

BRAKE SHOE



a	b	c	R	Shoe Only No.
4.5	2.0	20.0	86.0	M1299

K1299

NEW Regulation 90 approval Item (for EU market)

As for the MK No. * marks, we have more OE No. information.
Please e-mail to the following address if you want to know the more information.
e-mail address : mki@mkg.co.jp

In another way to find OE No. please use the Product Search in the MK Kashiwama web page.
<http://www.mkg.co.jp/global/en/product/search-by-part-number.html>

MK No.	Application	Approval No.
D11342H	VW GOLF7 TSI 13- VW TOURAN 16-17 AUDI A3/S3 1KE 13-	E1 90R-02A0014/0062
D3163M	MAZDA 3 BM/BN 13.07- MAZDA CX-3 DK 15.02-	E1 90R-02A0014/0066
D11124M *	Daewoo Evada 2.0 Petrol 08/02-12/04 Daewoo Lanos 1.4 Petrol 06/97- Daewoo Lanos 1.6 Petrol 06/97- Daewoo Leganza 2.0 Petrol 11/97- Daewoo Leganza 2.2 Petrol 04/99-12/02 Daewoo Nubira 1.4 Petrol 01/04-12/04 Daewoo Nubira 1.6 Petrol 06/97- Daewoo Nubira 1.8 Petrol 06/03- Daewoo Nubira 2.0 Petrol 06/97- Daewoo Tacuma/Rezzo 1.6 Petrol 09/00-12/04 Daewoo Tacuma/Rezzo 1.8 Petrol 09/00-12/04 Daewoo Tacuma/Rezzo 2.0 Petrol 09/00-12/04 Daewoo Lacetti 1.4 Petrol 01/04-12/04 Daewoo Lacetti 1.6 Petrol 01/04-12/04 Daewoo Lacetti 1.8 Petrol 01/04-12/04 Chevrolet Evada 2.0 Petrol 01/05- Chevrolet Tacuma/Rezzo 1.6 Petrol 01/05- Chevrolet Tacuma/Rezzo 2.0 Petrol 01/05- Chevrolet Nubira 1.4 Petrol 01/05- Chevrolet Lacetti 1.4 Petrol 01/05- Chevrolet Lacetti 1.6 Petrol 01/05- Chevrolet Lacetti 1.8 Petrol 01/05- Chevrolet Lacetti 2.0 Diesel Turbo 01/07-	E1 90R-02A0014/0064
D1241M *	SUZUKI SX4 RW415 SUZUKI SX4 RW415-3 SUZUKI SX4 RW416 SUZUKI SX4 RW416-2 SUZUKI SX4 RW416-3 SUZUKI SX4 RW415-4 SUZUKI SX4 RW416-4 SUZUKI SX4 RW416-5 SUZUKI SX4 RW420 NISSAN TEANA J31Z 02/07-	E1 90R-02A0014/0065
D9000 *	SUZUKI JIMNY 1.3 Petrol 08/98- SUZUKI JIMNY 1.3 Petrol 02/91- SUZUKI SJ410 1.0 Petrol 09/81-12/88 SUZUKI SJ413 1.3 Petrol 09/84-12/88	E1 90R-02A0014/0063
D2299M * D2299MH *	Toyota Auris 1.33 Petrol 09/08- Toyota Auris 1.4 Petrol 10/06- Toyota Auris 1.6 Petrol 10/06- Toyota Auris 1.4 Diesel Turbo 10/06- Toyota Auris 2.0 Diesel Turbo 10/06- Toyota Auris 2.2 Diesel Turbo 02/07- Toyota Corolla 1.4 Diesel Turbo 11/06- Toyota Corolla 2.0 Diesel Turbo 06/06-	E1 90R-02A0014/0067

NEW Regulation 90 approval Item (for EU market)

As for the MK No. * marks, we have more OE No. information.
Please e-mail to the following address If you want to know the more information.
e-mail address : mki@mkg.co.jp

In another way to find OE No. please use the Product Search in the MK Kashiyama web page.
<http://www.mkg.co.jp/global/en/product/search-by-part-number.html>

MK No.	Application	Approval No.
D2104 *	TOYOTA HI-ACE 2.4 Petrol 08/93-04/98 TOYOTA HI-ACE 2.7 Petrol 04/98- TOYOTA HI-ACE 2.4 Petrol 08/93- TOYOTA HI-ACE 2.5 Diesel Turbo 08/01-	E1 90R-02A0014/0068
D11160M	KIA PICANTO 1.0 PETROL 06/03-	E1 90R-02A0014/0069
D11160MH	KIA PICANTO 1.1 PETROL 06/03- KIA PICANTO 1.1 DIESEL TURBO 06/03- HYUNDAI I10 1.1L/1.2L 07.12-	

"Valuable information" Interchange information (Existing MK item)

MK No.	Application	Year
D0051M	SUZUKI ERTIGA <ASIA>	2012-
D0051M	MARUTI SUZUKI ERTIGA (1300cc,1400cc) <IND>	2015.10-
D11230MH	KIA K7 (2400cc,2700cc,3000cc,3300cc,3500cc) <KOR>	2009.11-2015.12
D11355MH	KIA NIRO HYBRID <EUR>	2016.04-
D1241M	MARUTI SUZUKI SX4 (1600cc PETROL) <IND>	2006.03-2014.03
D1241M	MARUTI SUZUKI SX4 (1300cc DIESEL) <IND>	2011.01-2014.04
D1241M	MARUTI SUZUKI S-CROSS (1300cc,1600cc DIESEL) <IND>	2015.07-
D5009	MARUTI SUZUKI 800 (800cc PETROL) <IND>	2000.01-2014.01
D9027	MALUTI SUZUKI ALTO800 (800cc PETROL) <IND>	2012.10-
D9027	MARUTI SUZUKI WAGON R (1000cc,1100cc PTEROL) <IND>	2003.03-
D9027	MARUTI SUZUKI ZEN ESTILO (1000cc PETROL) <IND>	2007.01-2014.02
D9029M	MARUTI SUZUKI A-STAR (1000cc PETROL) <IND>	2008.10-2014.02
D9039M	SUZUKI CIAZ AVB414 (1400cc) <AFC,CHL,HKG,PER,SAU,ZAF>	15-
D9039M	MARUTI SUZUKI CIAZ (1300cc,1400cc) <IND>	2014.11-
K7728	MARUTI SUZUKI 800 (800cc PETROL) <IND>	2000.01-2014.01
K9910	MARUTI SUZUKI OMNI (800cc PETROL) <IND>	2000.01-